

Antenna, Sensor, and Communications Trunk Line Connections

GT3 Series

<GT3, GT3B, GT3TK, and GT3TKW>

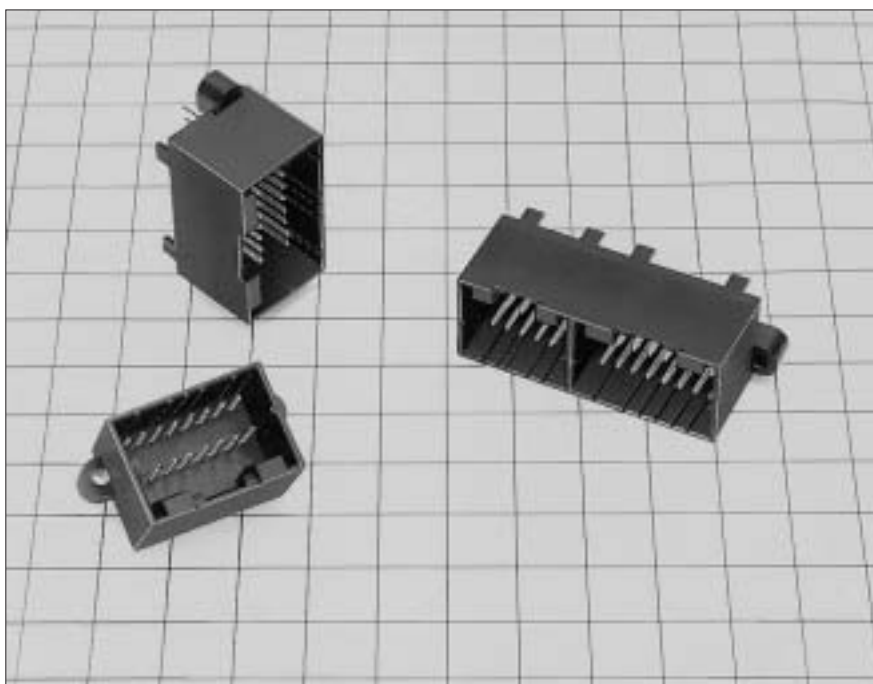

■ Features

- Available in a low-profile (GT3) and a standard (GT3B) type.
- Split type uses a mounting screw hole diameter of 2.6 mm.
- Tab width is size 040.

GT 1

GT 5

GT 13

GT 16

PO5G

GT 11

GT 14

GT 17

GT 19N

GT 2

GT 3

GT 6W

GT 7

GT 10

GT 12

GT 18W

GT 15

GT 8

GT 9

Interface Portions and In-line Portions of the Various Units and Devices

GT3 Series

M Connectors

● Printed Circuit Board mounting type

16 Pos.

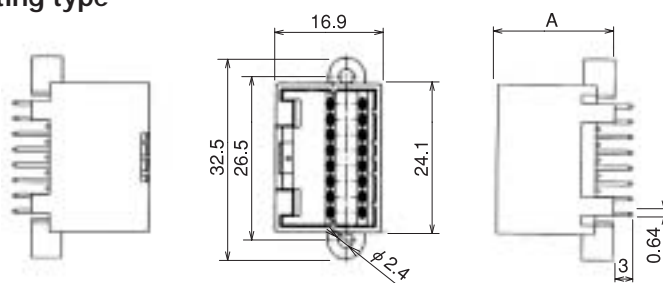

◆ Recommended Board Mounting Pattern

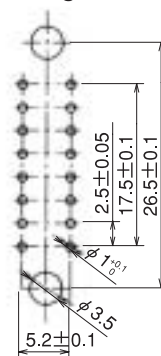

Part Number	CL No.	A Dimension
GT3-16DP-2.5DSA	753-0001-6	17
GT3B-16DP-2.5DSA	753-0003-1	19

Item	Material	Finish
Pin header	PBT	Color: Black
M terminal	Brass	Tin plating

Note: This product is a integral molding design.

20 Pos.

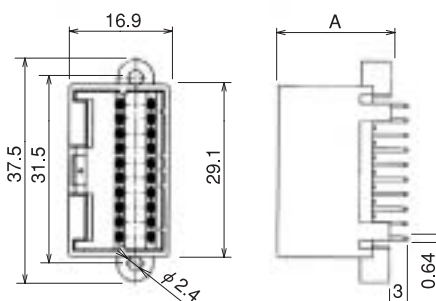

◆ Recommended Board Mounting Pattern

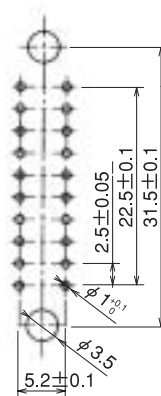

Part Number	CL No.	A Dimension
GT3-20DP-2.5DSA	753-0002-9	17
GT3B-20DP-2.5DSA	753-0004-4	19

Item	Material	Finish
Pin header	PBT	Color: Black
M terminal	Brass	Tin plating

Note: This product is a integral molding design.

● Split Type

12 Pos. + 16 Pos.

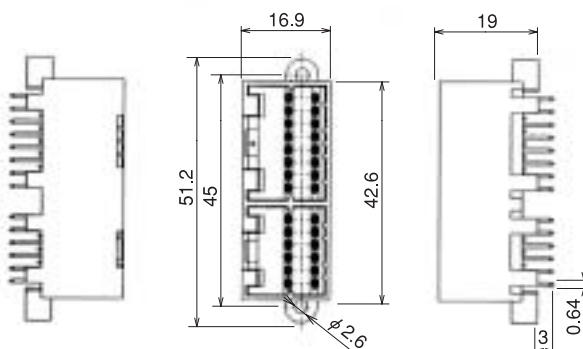
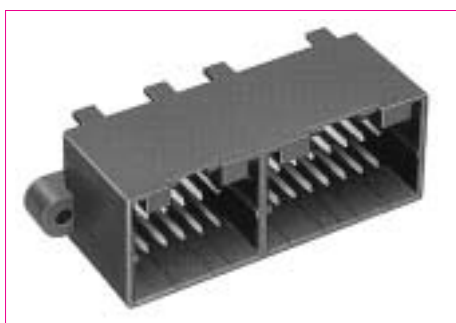

◆ Recommended Board Mounting Pattern

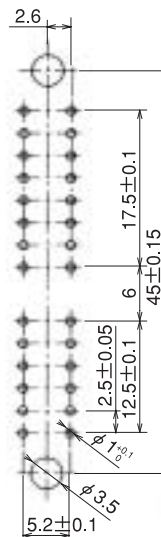

Part Number	CL No.	A Dimension
GT3B-12/16DP-2.5DSA	753-0005-7	17
		19

Item	Material	Finish
Pin header	PBT	Color: Black
M terminal	Brass	Tin plating

Note: This product is a integral molding design.

Interface Portions and In-line Portions of the Various Units and Devices

GT 1
GT 5
GT 13
GT 16
PO5G
GT 11
GT 14
GT 17
GT 19N
GT 2
GT 3
GT 6W
GT 7
GT 10
GT 12
GT 18W
GT 15
GT 8
GT 9

GT3TK Series

● Printed Circuit Board mounting type

8-Pos. Right Angle

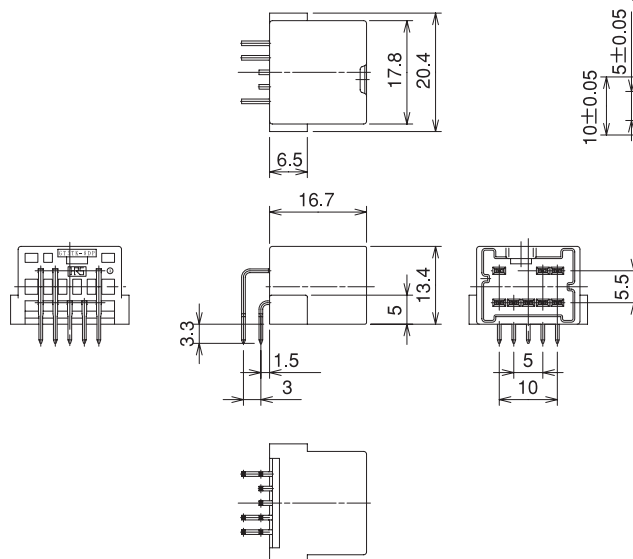
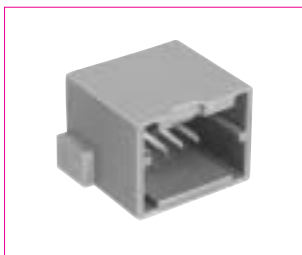

◆ Recommended Board Mounting Pattern

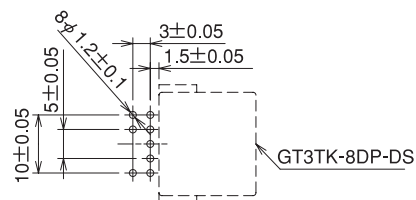

Part Number	CL No.	Material	Finish	Packaging
GT3TK-8DP-DS	753-0007-2	Brass (Terminal) PBT (Housing)	Tin plating Color: Brown	1

8-Pos. Straight

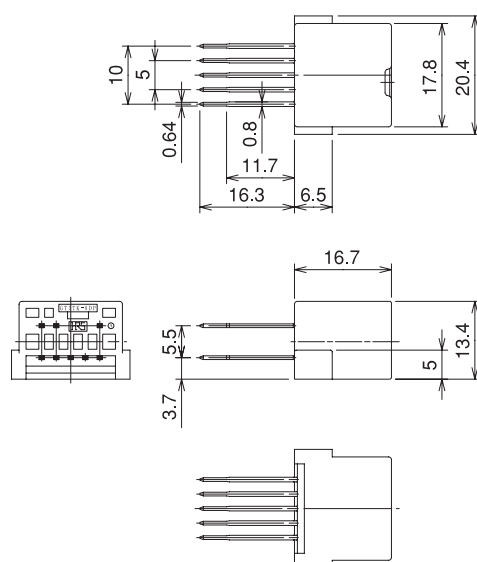
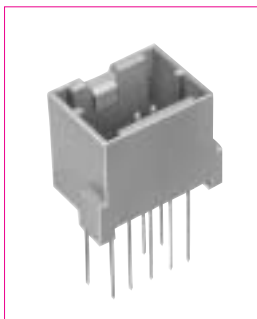

◆ Recommended Board Mounting Pattern

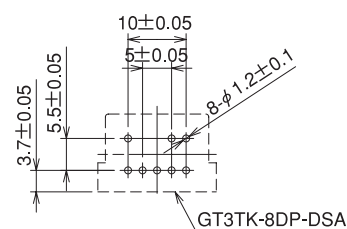

Part Number	CL No.	Material	Finish	Packaging
GT3TK-8DP-DSA	753-0018-9	Brass (Terminal) PBT (Housing)	Tin plating Color: Brown	1

GT3 Series

GT 1

GT 5

GT 13

GT 16

PO5G

GT 11

GT 14

GT 17

GT 19N

GT 2

GT 3

GT 6W

GT 7

GT 10

GT 12

GT 18W

GT 15

GT 8

GT 9

12-Pos. Right Angle



Recommended Board Mounting Pattern

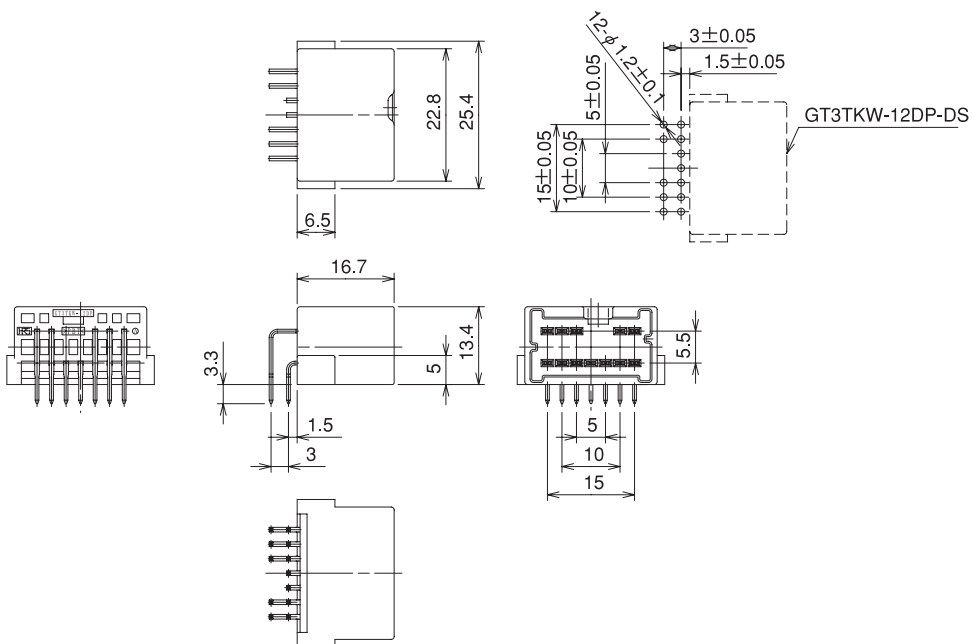

Part Number	CL No.	Material	Finish	Packaging
GT3TKW-12DP-DS	753-0010-7	Brass (Terminal) PBT (Housing)	Tin plating Color: Natural	1

12-Pos. Straight

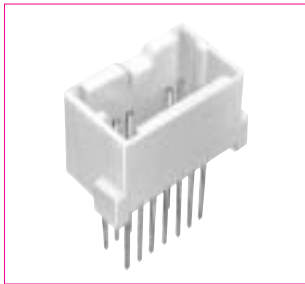

Recommended Board Mounting Pattern

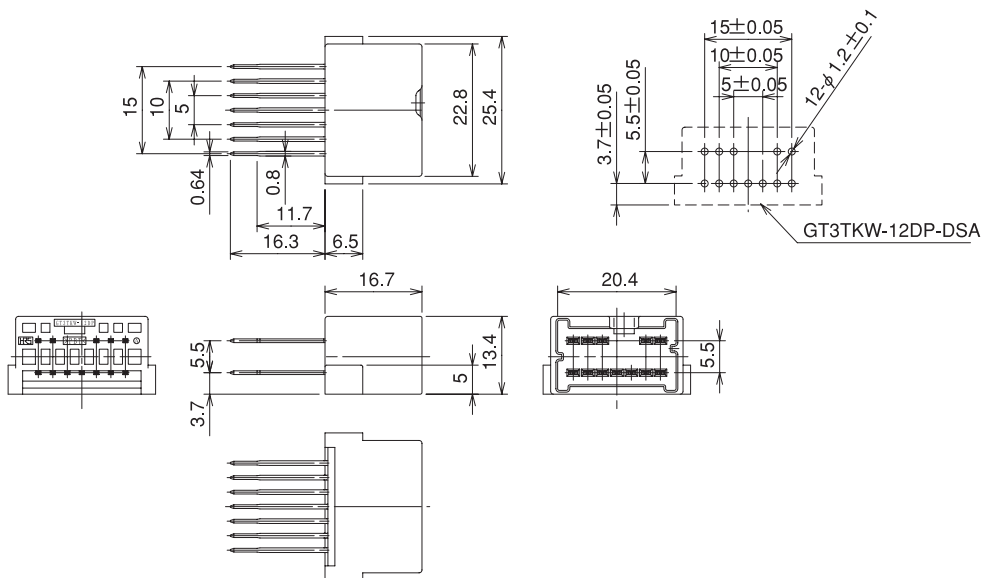

Part Number	CL No.	Material	Finish	Packaging
GT3TKW-12DP-DSA	753-0015-0	Brass (Terminal) PBT (Housing)	Tin plating Color: Natural	1

Interface Portions and In-line Portions of the Various Units and Devices

16-Pos. Right Angle

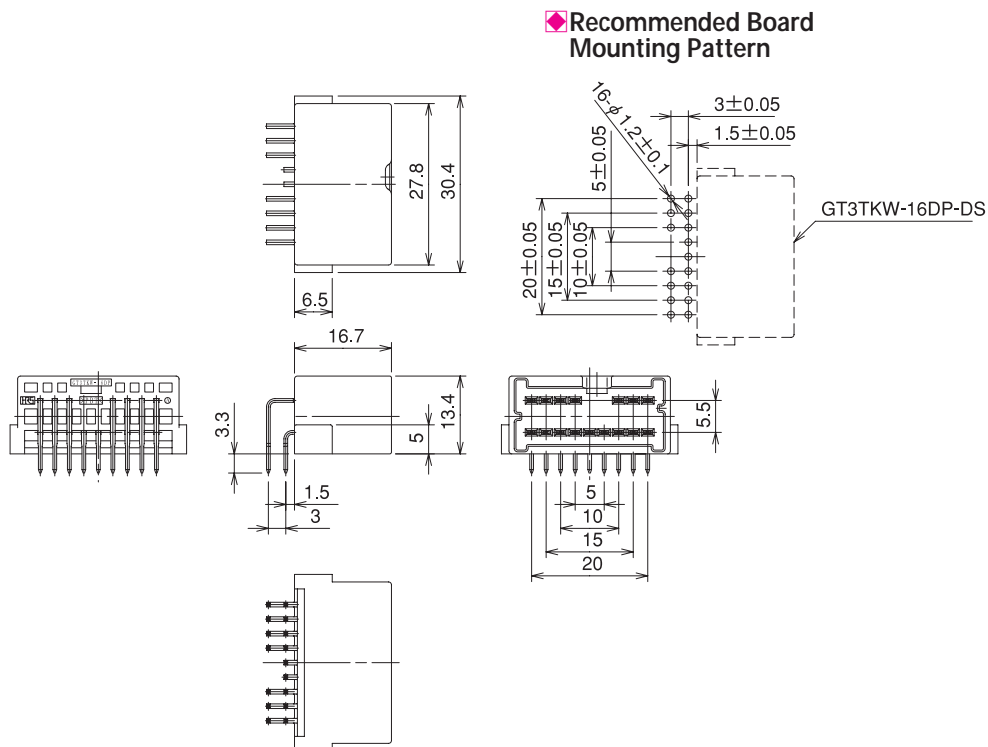

Part Number	CL No.	Material	Finish	Packaging
GT3TKW-16DP-DS	753-0011-0	Brass (Terminal)	Tin plating	1
		PBT (Housing)	Color: Natural	

16-Pos. Straight

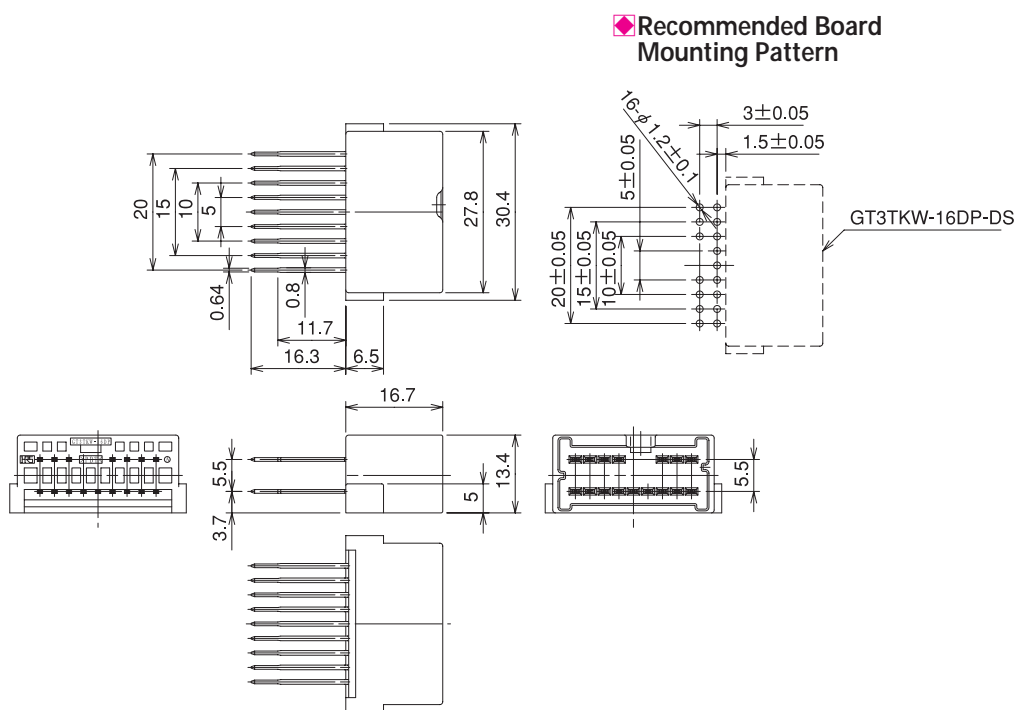
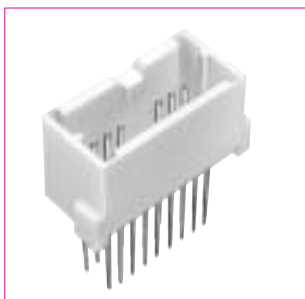

Part Number	CL No.	Material	Finish	Packaging
GT3TKW-16DP-DSA	753-0012-2	Brass (Terminal)	Tin plating	1
		PBT (Housing)	Color: Natural	

GT 1
GT 5
GT 13
GT 16
PO5G
GT 11
GT 14
GT 17
GT 19N
GT 2
GT 3
GT 6W
GT 7
GT 10
GT 12
GT 18W
GT 15
GT 8
GT 9

Interface Portions and In-line Portions of the Various Units and Devices

GT3 Series

24-Pos. Straight



Recommended Board Mounting Pattern

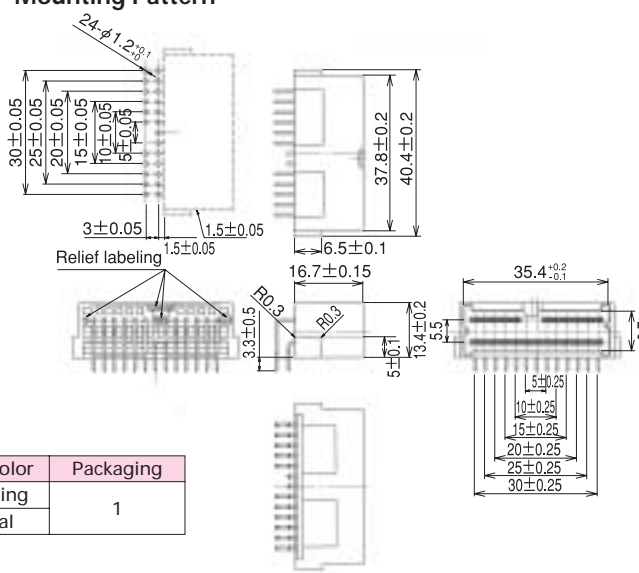

Part Number	HRS No.	Material	Finish,Color	Packaging
GT3TKW-24DP-DS	753-0019-1	Brass (Terminal) PBT (Housing)	Tin plating Natural	1

36-Pos. Straight

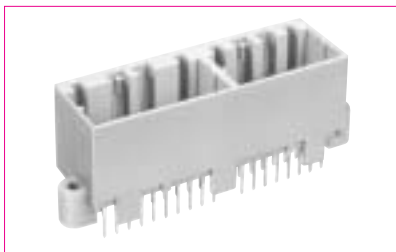

Recommended Board Mounting Pattern

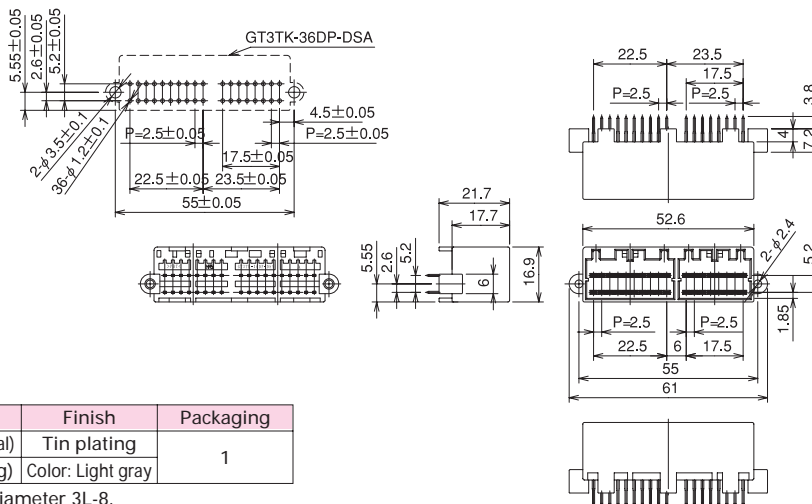

Part Number	CL No.	Material	Finish	Packaging
GT3TK-36DP-DSA	753-0017-6	Brass (Terminal) PBT (Housing)	Tin plating Color: Light gray	1

Note: Use mounting screws of M3 with nominal diameter 3L-8.

48-Pos. Right Angle

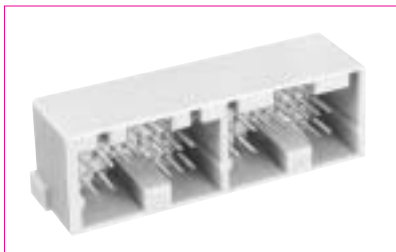

Recommended Board Mounting Pattern

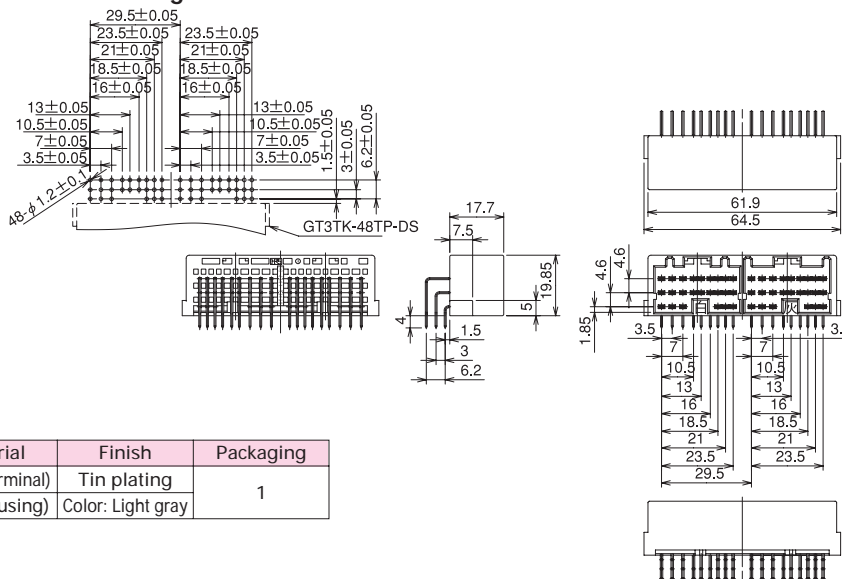

Part Number	CL No.	Material	Finish	Packaging
GT3TK-48TP-DS	753-0008-5	Brass (Terminal) PBT (Housing)	Tin plating Color: Light gray	1

Interface Portions and In-line Portions of the Various Units and Devices

- GT 1
- GT 5
- GT 13
- GT 16
- PO5G
- GT 11
- GT 14
- GT 17
- GT 19N
- GT 2
- GT 3
- GT 6W
- GT 7
- GT 10
- GT 12
- GT 18W
- GT 15
- GT 8
- GT 9